



Project _____

Item No. _____

Quantity _____

HIGH h CONVEYOR 1618



EXTERIOR CONSTRUCTION

- 430 stainless steel front, top, sides and back
- Cool to touch covers and panels

INTERIOR CONSTRUCTION

- All stainless steel interior construction
- 16-inch cook chamber opening

STANDARD FEATURES

- Independently-controlled top and bottom air impingement
- Variable-speed High h recirculating impingement airflow system
- Stackable design up to 3 high (requires stacking kits)
- Variable-speed blower motors
- Easy to clean mono-finger design
- Idle mode for energy conservation
- Built-in self diagnostics for monitoring oven components
- Left or right feed conveyor belt direction via software
- Includes plug and cord (6 ft. nominal)
- Includes two 6-inch conveyor extensions
- 36-inch conveyor belt assembly
- Warranty – one year parts and labor
- Smart voltage sensor technology (U.S. only)

OPTIONAL FEATURES

- 48-inch conveyor belt assembly
- 12 or 16-inch conveyor extensions
- Dual catalytic converters for ventless operation

PERFORMANCE

- The High h Conveyor 1618 offers high-heat transfer rates for accelerated cooking, a small enough footprint to fit virtually any application, and does not require the energy consumption and higher HVAC needs of larger ovens.

VENTILATION

- UL (KNLZ) listed for ventless operation.[†]
- EPA 202 test (8 hr):
 - Product: Pepperoni Pizza
 - Results: <1.12 mg/m³
 - Ventless Requirement: <5.00 mg/m³
- Internal catalytic filtration to limit smoke, grease, and odor emissions.

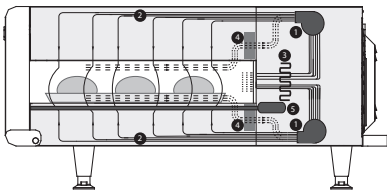

1. Blower Motors
2. Impinged Air
3. Impingement Heater
4. Catalytic Converters (optional)
5. Conveyor Motor



This product conforms to the ventilation recommendations set forth by NFPA96 using EPA202 test method.

[†] Ventless certification is for all food items except for foods classified as "fatty raw proteins." Such foods include bone-in, skin-on chicken, raw hamburger meat, raw bacon, raw sausage, steaks, etc. If cooking these types of foods, consult local HVAC codes and authorities to ensure compliance with ventilation requirements.

Ultimate ventless allowance is dependent upon AHJ approval, as some jurisdictions may not recognize the UL certification or application. If you have questions regarding ventless certifications or local codes please email ventless.help@turbochef.com

TurboChef reserves the right to make substitutions of components or change specifications without prior notice.



Front View

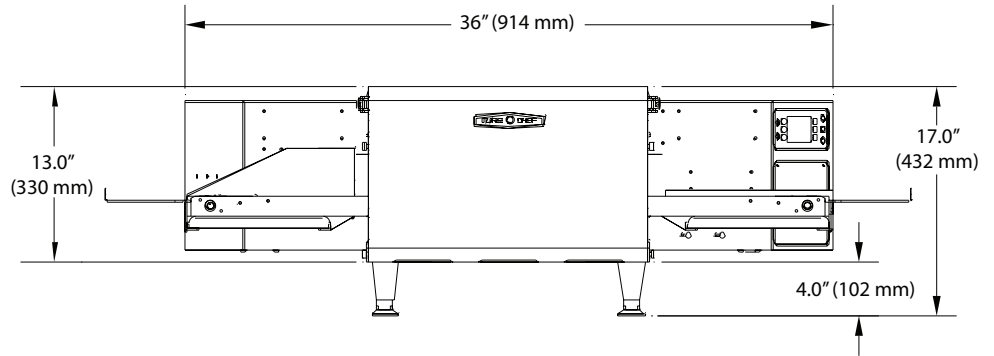

Side View

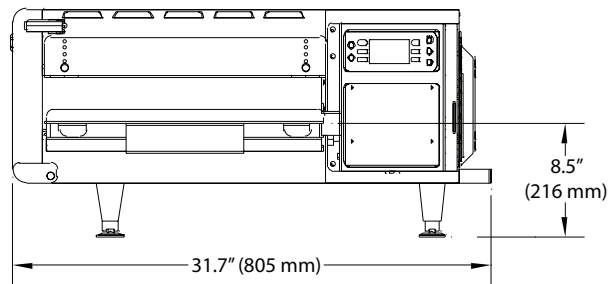

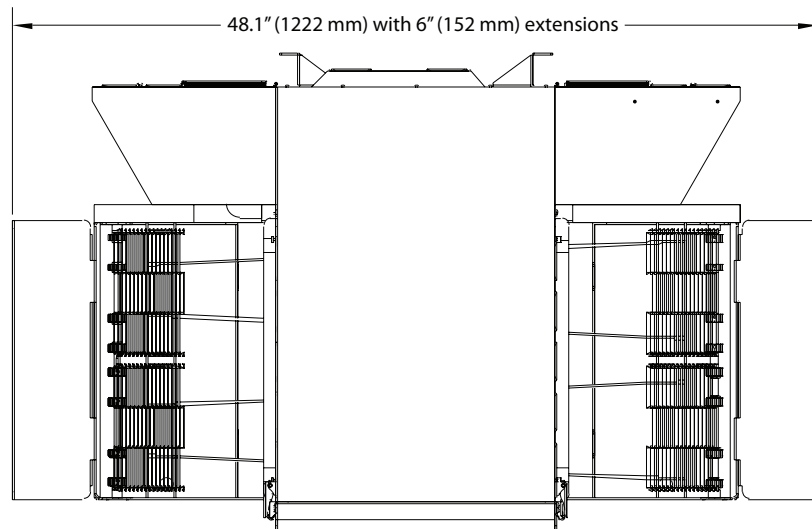

Top View (standard 36")



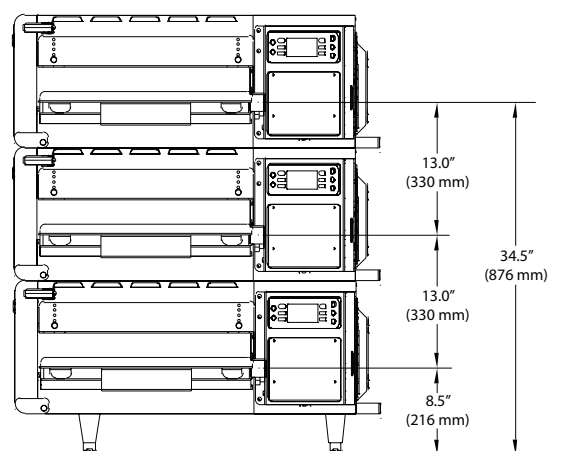
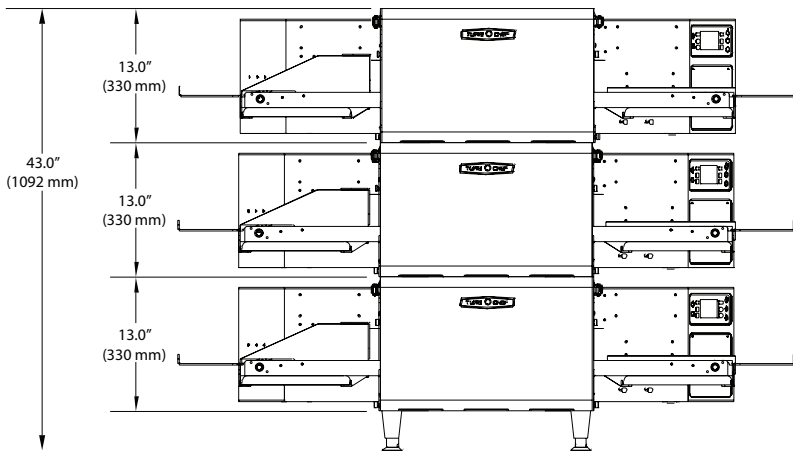
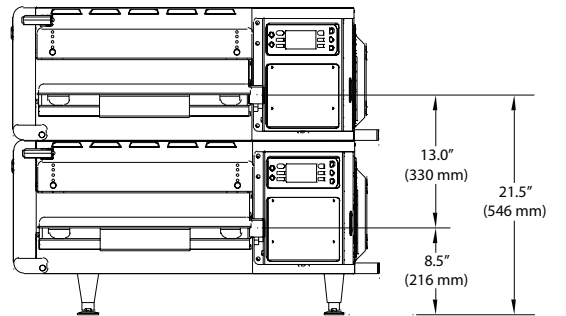
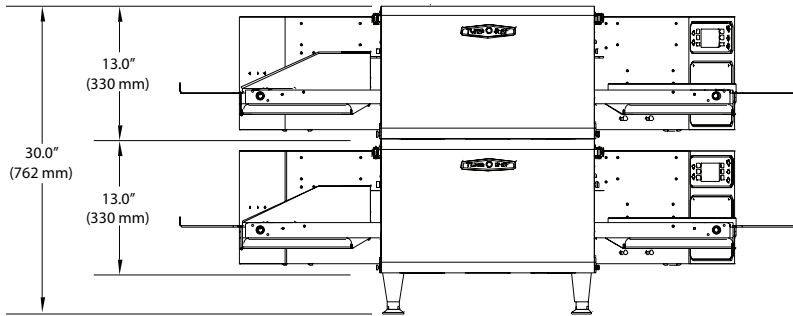

Stacked Views

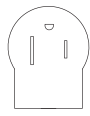
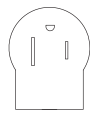

DIMENSIONS		
SINGLE UNITS		
Height	17.0"	432 mm
Width	36" or 48"	914 mm or 1219 mm
Depth	31.7"	805 mm
Weight (36" / 48")	195 lb. / 200 lb.	88.5 kg / 91 kg
Cook Chamber		
Baking Area	2 ft ²	0.15 m ²
Belt Length	36" or 48"	914 mm or 1219 mm
Belt Width	16"	406 mm
Adjustable Opening (Min/Max)	1" / 3"	25 mm / 76 mm
Max Operating Temp	600°F	316°C
Bake Time Range	30 seconds to 15 minutes	
Wall Clearance		
Top	10"	254 mm
Sides	0"	0 mm
Back	0"	0 mm
ELECTRICAL SPECIFICATIONS - SINGLE PHASE		
HCS-9500-1 (36-inch) – USA HCS-9500-6 (48-inch)		 NEMA 6-50P
Phase	1 Phase	
Voltage	208/240 VAC	
Frequency	50/60 Hz	
Current Draw	37 Amp	
Max Input	7.4 kW	
Supply	3 Wire	
Breakers	50 Amp	
HCS-9500-2C (36-inch) – Canada HCS-9500-7C (48-inch)		 NEMA 6-50P
Phase	1 Phase	
Voltage	208/240 VAC	
Frequency	50/60 Hz	
Current Draw	37 Amp	
Max Input	7.4 kW	
Supply	3 Wire	
Breakers	50/60 Amp	
ELECTRICAL SPECIFICATIONS - MULTIPHASE		
HCS-9500-11 (36-inch) – USA HCS-9500-12 (48-inch)		 NEMA 15-30P
Phase	3 Phase	
Voltage	208/240 VAC	
Frequency	50/60 Hz	
Current Draw	23 Amp	
Max Input	7.4 kW	
Supply	4 Wire	
Breakers	30 Amp	

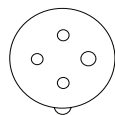
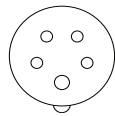
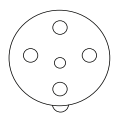
HCS-9500-3D (36-inch) - Europe/Asia Delta HCS-9500-8D (48-inch)		 UL 4 Pin, 32 Amp
Phase	3 Phase	
Voltage	220/240 VAC	
Frequency	50/60 Hz	
Current Draw	23 Amp	
Max Input	7.4 kW	
Supply	4 Wire	
Breakers	30 Amp	
HCS-9500-4W (36-inch) – Europe/Asia (WYE) HCS-9500-9W (48-inch)		 IEC 5 Pin, 20 Amp
Phase	3 Phase	
Voltage	380/415 VAC	
Frequency	50/60 Hz	
Current Draw	12 Amp	
Max Input	7.4 kW	
Supply	5 Wire	
Breakers	20 Amp	
HCS-9500-5W (36-inch) – Australia HCS-9500-10W (48-inch)		 IEC 5 Pin, 20 Amp
Phase	3 Phase	
Voltage	380/415 VAC	
Frequency	50/60 Hz	
Current Draw	12 Amp	
Max Input	7.4 kW	
Supply	5 Wire	
Breakers	20 Amp	
SHIPPING INFORMATION		
<p>U.S.: All ovens shipped within the U.S. are packaged in a double-wall corrugated box banded to a wooden skid.</p> <p>International: All International ovens shipped via Air or Less than Container Loads are packaged in wooden crates.</p>		
<p>36" conveyor belt: Box size: 36" (mm) x 41.8" (mm) x 17" (591 mm) Crate size: 44.5" (1130 mm) x 41" (1041 mm) x 23.25" (mm)</p>		
<p>48" conveyor belt: Box size: 41.7" (mm) x 53" (mm) x 17" (mm) Crate size: 58" (1473 mm) x 46" (1168 mm) x 28" (711 mm)</p>		
<p>Item class: 85 NMFC #26770 HS code 8419.81</p>		
<p>Approximate boxed weight (36" / 48"): 235 lb. (107 kg) / 255 lb. (116 kg) Approximate crated weight (36" / 48"): 310 lb. (141 kg) / 365 lb. (166 kg)</p>		
<p>Minimum entry clearance required for box: 36" conveyor belt: 38.5" (978 mm) 48" conveyor belt: 42" (1067 mm)</p>		
<p>Minimum entry clearance required for crate: 36" conveyor belt: 41" (1041 mm) 48" conveyor belt: 44.5" (1130 mm)</p>		

Note: To specify a ventless model on an oven order, add a "-V" to the end of the applicable part numbers listed above.

SEE OPPOSITE SIDE FOR ILLUSTRATIONS

TurboChef Global Operations
2801 Trade Center Drive
Carrollton, Texas 75007 USA
US: 800.90TURBO (800.908.8726)
International: +1 214.379.6000
Fax: +1 214.379.6073
turbochef.com